

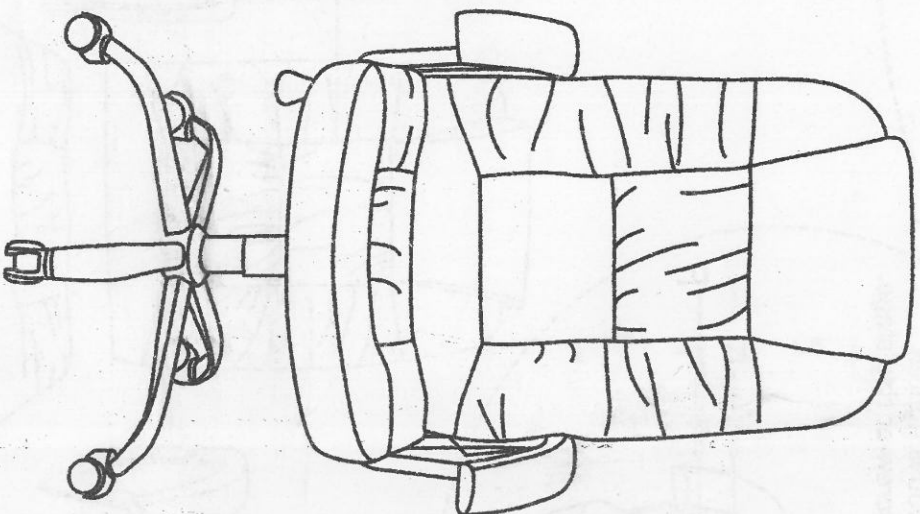

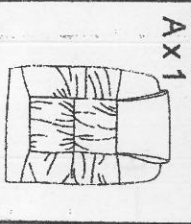

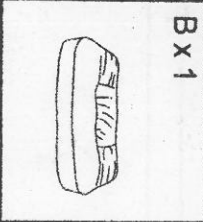

Moskala MEBLEN

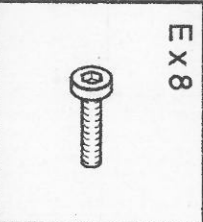
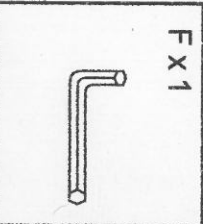
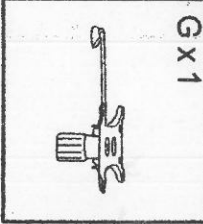
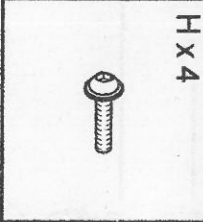

 Ax1	 Bx1	 Cx1	 Dx1	 Ex8	 Fx1
 Gx1	 Hx4	 Ix5	 Jx1	 Kx1	 Lx1

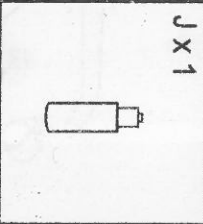
1

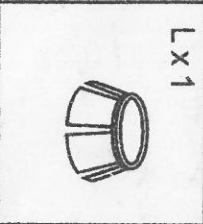
Step 2
100% tighten
screw at this stage.

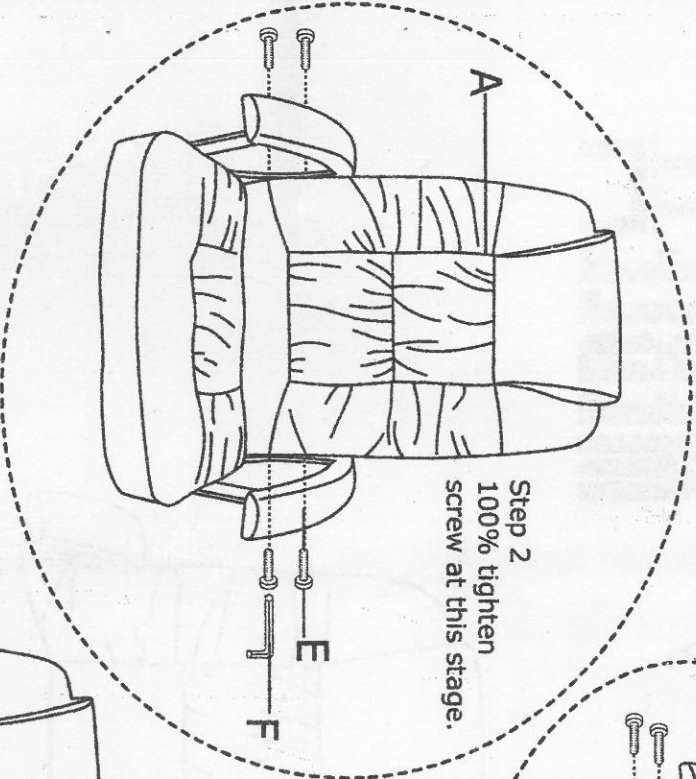

Step 1
80% tighten
screw at this stage.

